

Article number: 20664214A
Description: E+G Levelling set
GN 350.1-45-17.5-ST

Measures

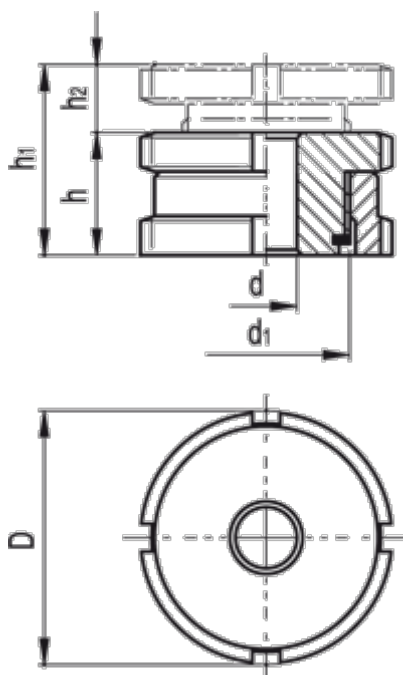

C-spanner DIN 1810 = A45-50
d = 17.5
D = 45
d1 = M30x1
For screw = M16
h = 22
h1 = 29
h2 = 7

Max static load (N) = 120.0
Static preload (N) = 45.5
Weight (g) = 188